

03 0307

Circular connectors with threaded joint M16 acc. to IEC 61076-2-106, IP40/IP67/IP68



Chassis socket acc. to IEC 61076-2-106, IP 68, with threaded joint, for printed circuit boards, for back side mounting

03 0307

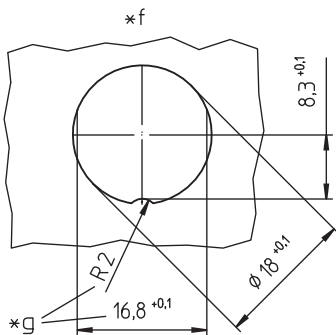
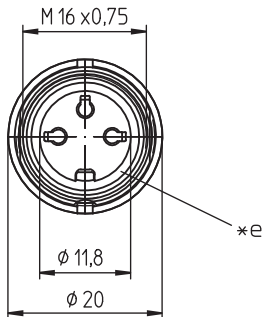
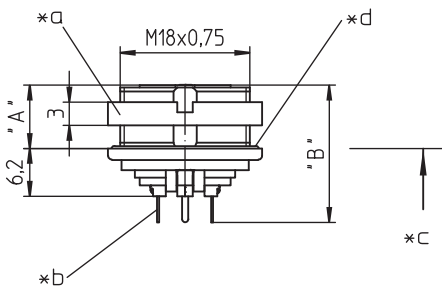
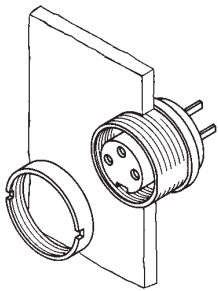

Environmental conditions

Temperature range -40 °C/+85 °C

Materials

Insulating body	PA GF, V-0 according to UL94
Contact bush	CuZn, silver-plated and flash gold-plated, tin-plated in solder area (3-8 poles) CuZn, pre-nickel and gold-plated, tin-plated in solder area (12-14 poles)
Housing	Zn diecast, pre-copper and nickel-plated
Ring screw	CuZn, nickel-plated
Seal	NBR

Mechanical data

Insertion force/contact	$\leq 5.0 \text{ N}^1$
Withdrawal force/contact	$\geq 1.2 \text{ N}$ (3-8 poles) $\geq 0.9 \text{ N}$ (12-14 poles) ¹
Protection class	IP68 ²

¹ measured with a polished steel pin, nominal thickness 1.5 mm (1.0 mm with 12-14 poles)

² according to IEC DIN EN 60529, only in locked condition with an appropriate counterpart; IPX8 requirements under agreement between manufacturer and user

Electrical data (at $T_{\text{amb}} 20 \text{ °C}$)

Contact resistance	$\leq 5 \text{ m}\Omega$
Rated current	5 A ($T_{\text{amb}} 40 \text{ °C}$, 3-8 poles) 3 A ($T_{\text{amb}} 40 \text{ °C}$, 12-14 poles)
Rated voltage	with pollution degree 1: 300 V (versions 03, 04, 05-1, 06, 07) 100 V (versions 05, 07-1, 08, 08-1) 160 V (versions 12, 14) with pollution degree 2: 250 V (versions 03, 04) 32 V (versions 05, 07-1, 08, 08-1) 160 V (versions 05-1, 06, 07, 12, 14)
Rated impulse voltage	1500 V (versions 03, 04, 05-1, 06, 07, 12, 14) 500 V (versions 05, 07-1, 08, 08-1)
Material group	II (IEC)/1 (UL) (CTI ≥ 550)
Overvoltage category	I
Insulation resistance	$> 100 \text{ M}\Omega$

03 0307

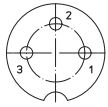

03-a
0307 03

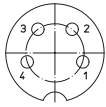

04-a
0307 04

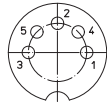

05-b
0307 05

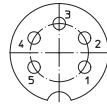

05-a
0307 05-1

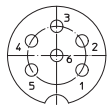

06-a
0307 06

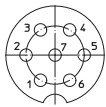

07-a
0307 07

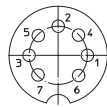

07-b
0307 07-1

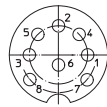

0307 08

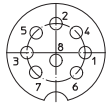

08-a
0307 08-1



12-a
0307 12

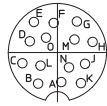

14-a
0307 14

Associated products

Counterparts

☑ 0331	☑ 0332	☑ 0332-1
☑ 033200	☑ 0365	☑ 036500

Accessories

☑ 0322 C 16	☑ 0381	☑ 038199
☑ 0384	☑ 0385	☑ 038799

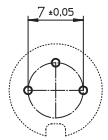

03-a
0307 03

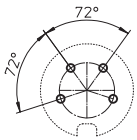

04-a
0307 04

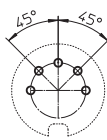

05-b
0307 05

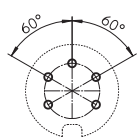

05-a
0307 05-1

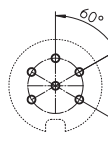

06-a
0307 06

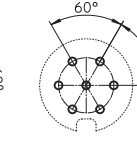

07-a
0307 07

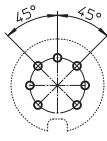

07-b
0307 07-1

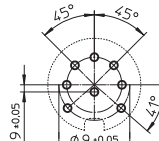

0307 08

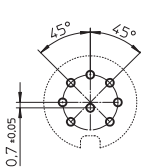

08-a
0307 08-1

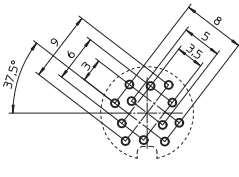

12-a
0307 12

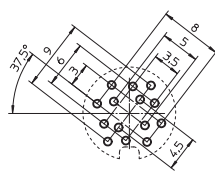

14-a
0307 14

03

0307

-
- *a nut enclosed separately
 - *b for bore hole of PCB
Ø 1,0 mm (0307 03-0307 08-1)
Ø 0,7 mm (0307 12-0307 14)
 - *c mounting direction
 - *d O-ring gasket
 - *e flat gasket
 - *f port in mounting plate
 - *g anti-rotation, alternative execution

03 0307

Designation	Pole Number	PU (Pieces)	MDQ (Pieces)	Dimensions	
				A (mm)	B (mm)
0307 03	3	50	100	8.2	17.8
0307 04	4	50	100	8.2	17.8
0307 05	5	50	100	8.2	17.8
0307 05-1	5	50	100	8.2	17.8
0307 06	6	50	100	8.2	17.8
0307 07	7	50	100	8.2	17.8
0307 07-1	7	50	100	8.2	17.8
0307 08	8	50	100	8.2	17.8
0307 08-1	8	50	100	8.2	17.8
0307 12	12	50	100	7.9	17.1
0307 14	14	50	100	7.9	17.1

Packaging:
in a cardboard box